

COMFORT TRACK™

INSTALLATION AND APPLICATION GUIDE

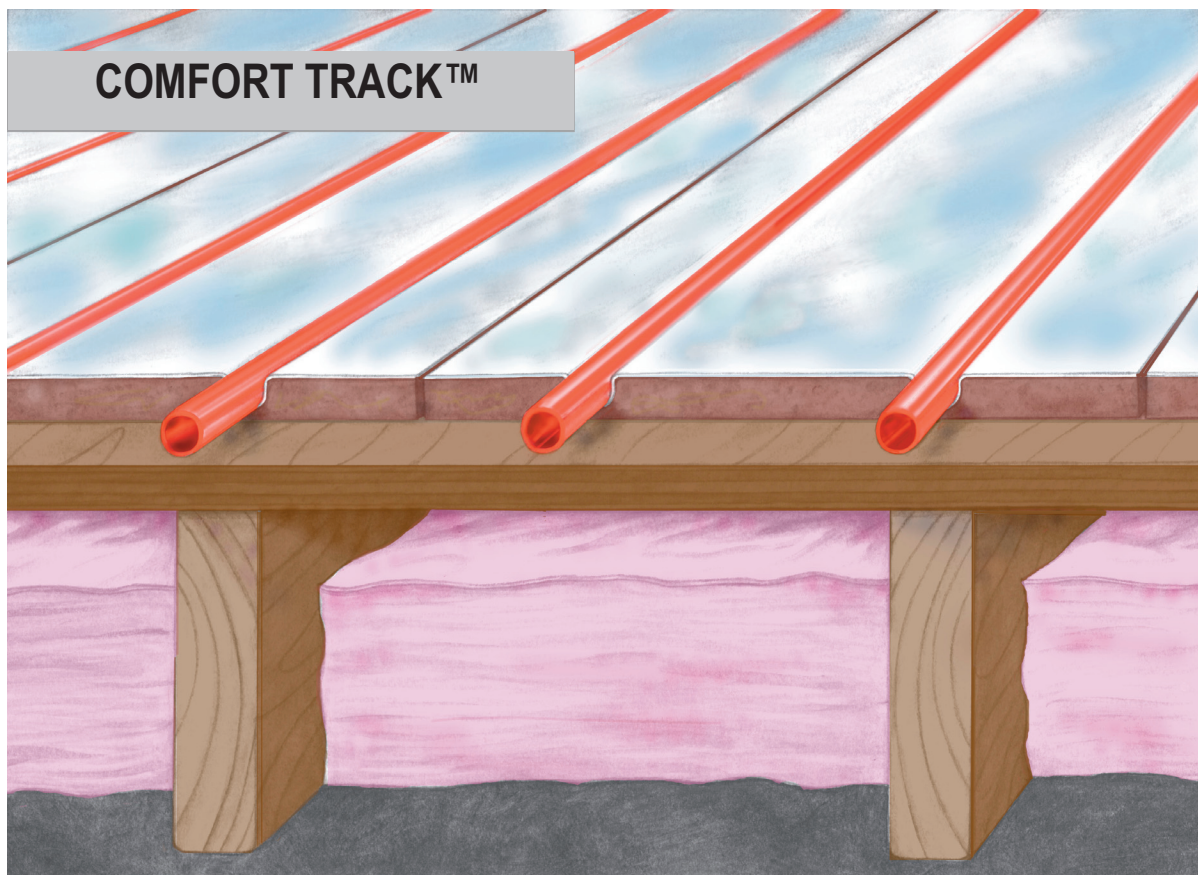

MODULAR RADIANT THERMAL MASS



315 Oser Avenue
Hauppauge, NY 11788
Phone: (631) 694-1800
Fax: (631) 694-1832

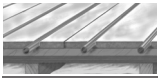

INSTALLATION AND APPLICATION GUIDE FOR COMFORT TRACK™

U.S. Patent # 6,533,185

Other Patents Pending

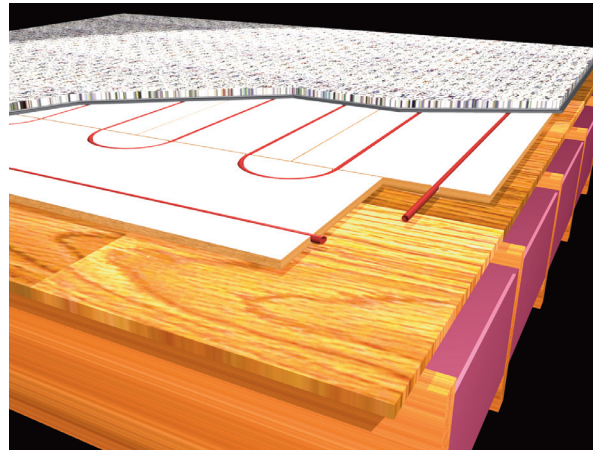

Contents

| | |
|--|------------------|
| <i>COMFORT TRACK™, HOW IT WORKS:</i> | <i>3</i> |
| <i>COMFORT TRACK™ WARMCOAT:</i> | <i>3</i> |
| <i>CHART C-1 COMFORT TRACK™</i> | <i>5</i> |
| <i>AVERAGE WATER TEMPERATURES</i> | <i>5</i> |
| <i>STEADY STATE PERFORMANCE</i> | <i>5</i> |
| <i>HEAT LOSS:</i> | <i>5</i> |
| <i>R-VALUE OF FLOOR ASSEMBLIES</i> | <i>5</i> |
| <i>COMPONENTS:</i> | <i>6</i> |
| <i>COMFORT TRACK™ PRODUCT HANDLING INFORMATION:</i> | <i>7</i> |
| <i>COMFORT TRACK™ STORAGE:</i> | <i>7</i> |
| <i>ESTIMATING THE REQUIRED NUMBER OF COMFORT TRACK™:</i> | <i>7</i> |
| <i>TUBING:</i> | |
| <i>CHART C-2 3/8" PEX FLOW DATA:</i> | <i>8</i> |
| <i>SPACING OF BOARDS:</i> | <i>8</i> |
| <i>OVERVIEW OF FLOOR SURFACE REQUIREMENTS:</i> | <i>8</i> |
| <i>EQUIPMENT REQUIRED FOR INSTALLATION:</i> | <i>9</i> |
| <i>LAYOUT AND INSTALLATION:</i> | <i>10</i> |
| <i>GLUEING, SCREWING AND STAPLING COMFORT TRACK™</i> | <i>11</i> |
| <i>CONNECTIONS AT MANIFOLD:</i> | <i>13</i> |
| <i>NOTE ON CAULKING GROOVES.</i> | <i>13</i> |
| <i>APPLICATION – CARPET OVER SUBFLOOR:</i> | <i>14</i> |
| <i>APPLICATION – LAMINATE OR VINYL OVER SUBFLOOR:</i> | <i>15</i> |
| <i>APPLICATION – WOODS OPTIONS OVER COMFORT TRACK™:</i> | <i>16</i> |
| <i>APPLICATION – HARDWOODS OVER SUBFLOOR:</i> | <i>17</i> |
| <i>APPLICATION – CONSIDERATIONS FOR TRADITIONAL HARDWOOD FLOORS:</i> | <i>18</i> |
| <i>APPLICATION – TILE/STONE OVER SUBFLOOR:</i> | <i>19</i> |
| <i>APPLICATION – OVER SLAB:</i> | <i>19</i> |
| <i>APPLICATION OVER SLAB, REGULAR FLOOR GOODS EXCEPT STRIP WOOD FLOORING:</i> | <i>22</i> |
| <i>APPLICATION OVER SLAB, STRIP WOOD FLOORING</i> | <i>23</i> |
| <i>APPLICATION – WALL</i> | <i>24</i> |
| <i>DESIGN SERVICES:</i> | <i>25</i> |
| <i>EXAMPLE NRDC DESIGN:</i> | <i>27</i> |
| <i>CAUTIONS AND LIMITATIONS OF USE:</i> | <i>28</i> |

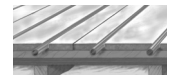

COMFORT TRACK™, HOW IT WORKS:

Comfort track™ are typically glued and screwed or stapled to a wood subfloor or glued to cement. Then PEX pipe, which will carry warm water, is snapped into the groove. Heat is transferred from the pipe to the aluminum and the board. Comfort track™ are manufactured from MDF (medium density fiber board), or dense OSB (oriented strand board) which are relatively conductive wood products weighing 44-50 lbs. per cubic foot. The board is grooved and then laminated with a top layer of highly conductive aluminum to efficiently disperse and transfer heat away from the groove to the surface area of the whole board.



FIGURE A-1, a cross section, showing PEX pipe in groove and board with aluminum top layer

Acceleration is a measure of how fast a radiant heating systems responds. Aluminum is approximately 1000 times more conductive for wood. The layer of aluminum on Comfort Track™ and in the groove, significantly enhances the transfer of heat and evenness of heat distribution of the board. See illustration A-2 to see how the heat transfers through Comfort Track™. The thin profile and relatively high density contributes to the superior acceleration and deceleration of Comfort Track™.

Traditional radiant heating systems in concrete work well but they must first charge a large thermal mass before heat will begin coming out of the panel. They accelerate and decelerate very slowly due to the large thermal mass and they can be hard to control. Comfort Track™, being thin but relatively dense and aided by its conductive aluminum layer responds very rapidly. This results in greatly improved response time with almost no overheating since there is almost no “thermal lag” to overcome. Comfort track™ can be controlled with standard set back thermostats.

Comfort Track™ WARMCOAT:

The Comfort Track™ Warmcoat aluminum top layer provides multiple benefits. It is highly conductive.. The Warmcoat aluminum layer is also moisture resistant. When the edges and grooves of the Comfort track™™ are sealed using the Comfort track™ thermal sealant, it provides significant moisture protection for the board. And it provides a barrier to the transmission of any outgassing from the board. Comfort Track™ is manufactured to meet the less than 0.3 ppm formaldehyde Federal Housing Authority (FHA) standards. Independent laboratory tests with 144F° water indicate, that due to the aluminum Warmcoat layer, Comfort Track™ has virtually no detectable levels of outgassing.

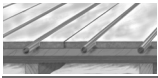

THE ADVANTAGES OF COMFORT TRACK™:

Hydronic radiant heating is the most comfortable and efficient way to heat your home or building with numerous construction benefits and unsurpassed flexibility in zoning. For many years typical applications for radiant systems involved embedding tubing in concrete slabs or pouring “light-weight concrete” over tubing stapled to sub-floors. The lack of good alternatives to these types of systems permitted designers to overlook the limitations and disadvantages of concrete systems. Comfort track™ is designed for the application of hydronic radiant tubing over a variety of construction types. Comfort Track™ may be used in new construction and is advantageous in the growing retrofit market. While only adding 5/8” to the existing floor height, Comfort track™ provides a superior performing radiant heating system. Application of the system is made easy because only three types of pieces are required for installation.

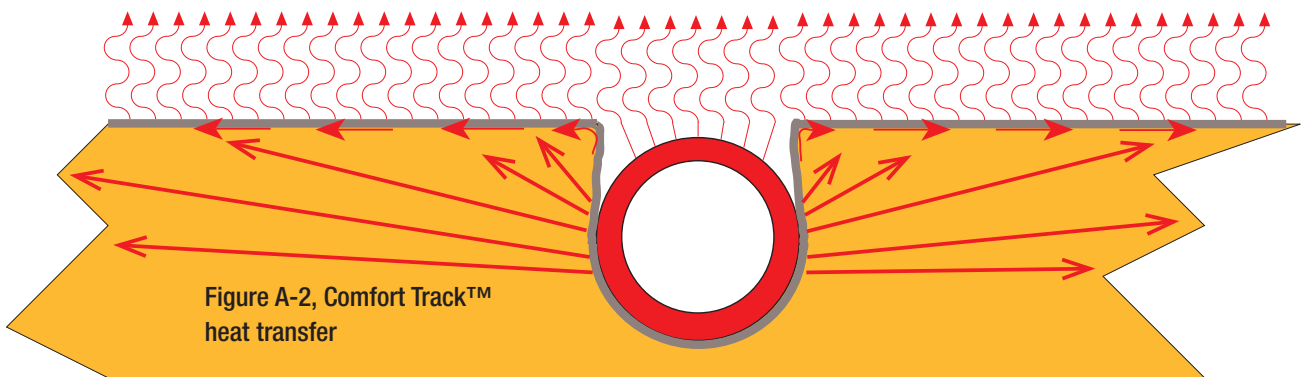

The Comfort Track™ radiant floor heating system provides an attractive alternative to concrete with numerous advantages:

- Superior performing, high density thermal mass
- Excellent response time to heat up/cool down
- Easy layout and installation
- Lightweight – 5 times lighter than concrete
- Even distribution of heat
- Superb design and zoning flexibility
- Excellent compatibility with floor coverings
- Lightweight: reduces need for structural upgrades

Figure A-3 RESPONSE TIME:
notice how in these to scale side by side drawings
how much more mass pipe in 4 inches of cement
must overcome before it begins giving off heat.

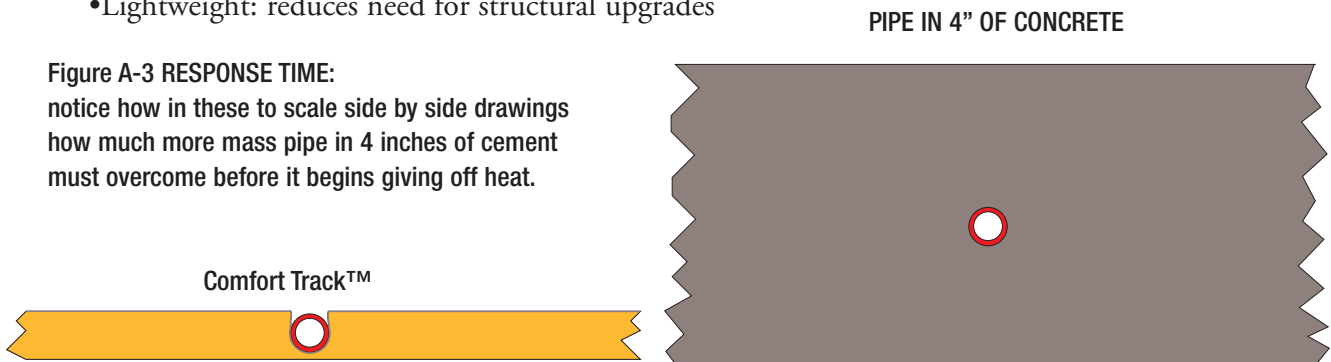

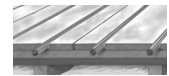

STEADY STATE PERFORMANCE

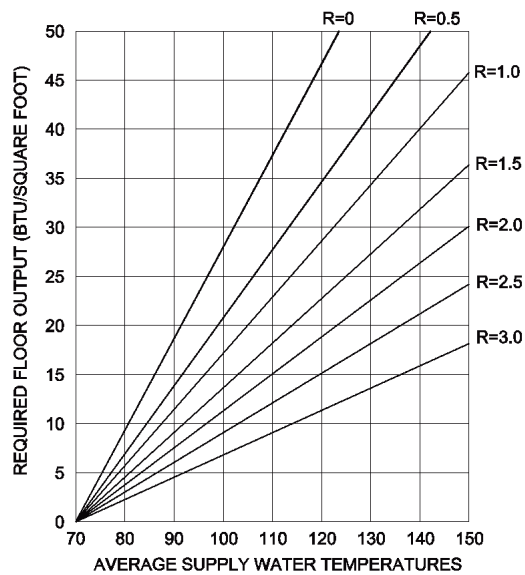

CHART C-1

CHART C-1

This chart shows the steady state performance of Comfort Track™. To the left are the BTU/Sq.Ft/Hour, the lines represent the resistance of the floor coverings on top of Comfort Track™ and on the bottom is the average water temperature required to achieve the output. The chart is read by selecting the correct BTU requirement and then moving horizontally until the line indicating the correct R-Value of the floor assembly on top of Comfort track™ is encountered, at that point drop down vertically to see average water temperature.

Installers Note:

Remember average water temperature means the average of the supply and return water temperatures flowing to and from the loop. Most typically Comfort Track™ is designed with a 20F° temperature drop. This means the supply water temperature would typically be 10F° higher than the average water temperature.

HEAT LOSS:

As with all floor heating jobs a detailed and accurate heat loss must be calculated in order to determine proper design conditions. This may be provided by a design service (See Design Services) Refer to the 1999 Radiant Panel Association Guidelines For The Installation Of Radiant Panel Systems for standards on insulation and heat loss. The maximum recommended supply water temperature for comfort track™ is 150F°.

Installers and designers note:

Perform the heat loss of the structure at the design stage. This way selection of floor coverings can be made with the requirements of the system in mind. If the heat loss is too high, add insulation or auxiliary heat. In a very high heat loss room Comfort Track™ might be added to the walls or ceilings for extra heat.

R-VALUE OF FLOOR ASSEMBLIES

While Comfort Track™ will work with a wide variety of floor coverings over the top of the boards it is important to realize that all floor coverings offer a resistance to heat transfer as measured typically by their R-Value. As with all radiant systems, the higher the R-Value of the floor covering

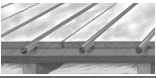

the higher the average water temperature it takes to overcome this resistance and to generate the desired amount of heat. If the R-value of any covering on top of Comfort track™ becomes excessive, as in any radiant heating system performance will be compromised due to lack of heat transfer, or by exceeding the 150F° maximum supply water temperature. Chart C-1 can be used to estimate system output with different floor coverings

Installers and designers note:

Learn about the resistance of the intended floor coverings at the design stage and make sure that they are within the requirements of the system.

COMPONENTS:

Comfort Track™ comes in 3 different board configurations. These are “straight”, “utility” and “combo end piece”. They are assembled to make a channel for the pipe. Comfort track™ cut easily with a circular saw.

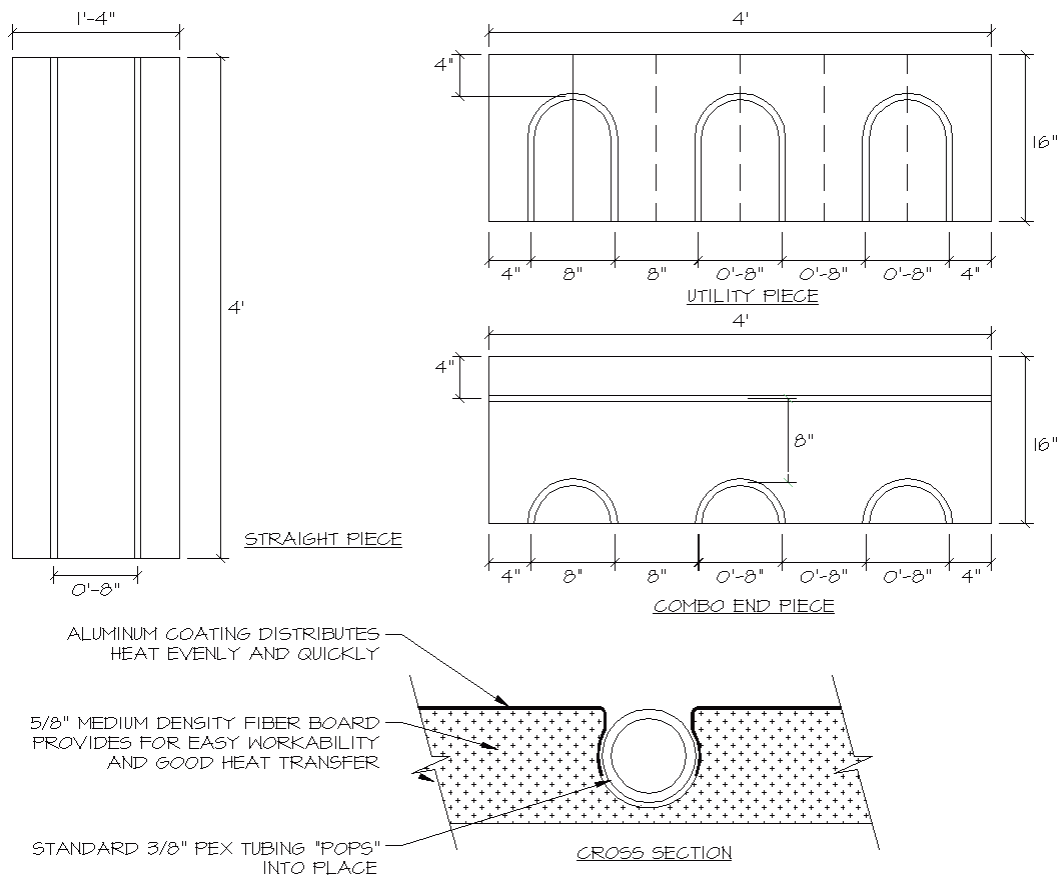
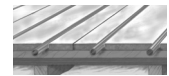

Illustration A-4, Comfort Track™ components



COMFORT TRACK™ PRODUCT HANDLING INFORMATION:

Nominal dimensions: each board is 16" x 48" x 5/8" thick, or 5.333 square feet a board

Weight: approximately 2.5lbs per square foot, 13.3 lbs. per board

Pallet Size: 4' x 4' x 24" tall (3 Comfort track™ to a row, 32 rows high)

Approximate Pallet Weight: 1280lbs.

Approximate Truckload Quantities: 16,885.44 square feet or 33 pallets 42,214 lbs.

Pallet Appearance: shrink wrapped corner protected color coded corners by part #

Recommended Product Mix: straight 70% combo end 15%, utility 15%, allow 10% extra for waste.

COMFORT TRACK™ STORAGE:

Comfort track™ should be stored in a temperate, dry place (40F°-90F°). Avoid prolonged exposure to sunlight. Do not store in a damp location.

ESTIMATING THE REQUIRED NUMBER OF COMFORT TRACK™:

For simple and fast installation, it highly recommended that a full Comfort track™ layout be used which indicates precise panel and tubing layout. This can be provide by the National Radiant Design Center (See Design services). A plan is recommended for the first few jobs.

For experienced installers, calculate the net square footage of each room and multiply by the following factors: Straight – 0.133 Utility – 0.028 Combo End – 0.028

Example: For a 600 sq. ft. room, multiplying 600 by 0.133 gives approximately 80 straight boards. Multiplying 600 by 0.028 gives 17 Utility pieces. Multiplying 600 by 0.028 gives 17 Combo end pieces. It is always recommended that a 10% material excess be added to the estimation.

TUBING:

Comfort track™ is designed for use with 3/8" nominal ASTM F-876 PEX (cross linked Polyethylene) with an average outer diameter measuring .5". Loops shall never be over 250 feet including the leaders to manifolds. For areas with heat loss greater than 25 BTU/Sq.Ft. loops shall never be over 200 ft. This is due to high pressure drops and water velocity as shown in the following chart C-2* (greyed area over 25 BTU/Sq.Ft). Friction losses in chart are approximate, actual friction losses depend on fluid viscosity and temperature.

*Shaded area in 250' loop chart C-2 on the following page indicates high pressure drop. It is recommended to use the shorter 200' loop length in this case, as shown in the second chart.

Once the room square footage is determined, multiply the total by 1.5.

Example: For a 600 sq. ft. room, multiplying 600 by 1.5 gives 900 lineal feet of 3/8" PEX tubing. This room would require 4 loops at 225 ft each. Alternatively three 250 foot loops and one 150 foot loop could be used, provided that means were provided to balance the flow to the different loops by balancing valves.

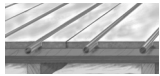

COMFORT TRACK™ 250' Loops 20°F Temp Drop*

| | | | | | | | |
|--------------------------|-------|-------|-------|-------|-------|-------|-------|
| BTU/SQ/FT | 10.00 | 15.00 | 20.00 | 25.00 | 30.00 | 35.00 | 40.00 |
| Friction Loss (Ft. Head) | 2.22 | 4.70 | 8.01 | 12.10 | 16.96 | 22.80 | 28.87 |
| Water Speed (Ft./Second) | 0.60 | 0.90 | 1.20 | 1.50 | 1.80 | 2.10 | 2.40 |
| GPM Per Loop | 0.18 | 0.27 | 0.36 | 0.45 | 0.54 | 0.63 | 0.72 |

*Shaded areas have high head loss

COMFORT TRACK™ 200' Loops 20°F Temp

| | | | | | | | |
|--------------------------|-------|-------|-------|-------|-------|-------|-------|
| BTU/SQ/FT | 10.00 | 15.00 | 20.00 | 25.00 | 30.00 | 35.00 | 40.00 |
| Friction Loss (Ft. Head) | 0.98 | 2.07 | 3.53 | 5.33 | 7.47 | 9.93 | 12.72 |
| Water Speed (Ft./Second) | 0.45 | 0.68 | 0.90 | 1.13 | 1.35 | 1.58 | 1.80 |
| GPM Per Loop | 0.14 | 0.20 | 0.27 | 0.34 | 0.41 | 0.47 | 0.54 |

CHART C-2 3/8" PEX FLOW AND PRESSURE LOSS DATA

SPACING OF BOARDS:

The actual width of each board is 15 7/8" which provides a built-in gap between boards for expansion at different temperatures.

Contractors Note: Be sure to follow all instructions elsewhere in this manual regarding protecting the board from prolonged moisture contact, if these instructions are not followed, expansion of greater magnitude could create undesirable effects. See illustration.

OVERVIEW OF FLOOR SURFACE REQUIREMENTS:

Note: See also the specific application drawings and notes for installing Comfort Track™ that follow in this manual.

SUBFLOOR REQUIREMENTS GENERAL :

The surface of the subfloor must be flat. The requirement for flatness is defined as the maximum difference between two adjacent high points and the intermediate low point. The maximum acceptable difference in level is 3/16 of an inch in a 10-ft. radius.

Fill excessive voids or low areas using a leveling compound. Allow the leveling compound to dry thoroughly before beginning the installation. Check with the leveling compound manufacturer to be sure it is appropriate for the application. High areas can be ground down or floated over with a self-leveling compound.

The surface of the floor must be clean and dry.

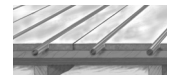

SUBFLOOR REQUIREMENTS, WOOD SUBFLOORS:

Wood subfloors must have a stable moisture content between 6 – 10%.

Creaking subfloors must be repaired before installation. If the subfloor sags, inspect the joists below for twists or weakness. If the subfloor is cupped or uneven at the joints, recheck the moisture content of the subfloor to be sure it is in the 6 – 10% range. Check for excessive moisture in the crawl space or basement and look for other signs of a potential water problem.

High areas are sanded or planed, low areas patched or filled with an appropriate leveling compound, or covered with a rigid underlayment. When using a leveling compound, be sure to follow the manufacturer's recommendations, and allow the compound to dry completely before starting to install the floor.

SUBFLOOR REQUIREMENTS, CONCRETE SUBFLOORS:

See specific details that follow in the application section of this manual.

EQUIPMENT REQUIRED FOR INSTALLATION:

The following is necessary for the installation of Comfort track™:

- Table or circular saw. A carbide blade is recommended.
- Electric or cordless drill gun with No. 2 Phillips bit and 5/8" drill bit for supply and return bury points.
- Rubber or hard hide mallet
- Chalk line
- Square

Recommended optional items:

- Stand up drill
- Groove alignment tool
- If installing over concrete you may need insulation and waterproofing sealant membrane material as well as a compatible mastic for engineered wood products and appropriate rollers and trowels

Installers note:

Comfort Track™ cuts easily with a quality circular saw blade. Pieces frequently must be cut to provide an accurate fit for each room. It is important that they be cut squarely to keep the alignment of grooves accurate in the installation. If you are installing large areas of Comfort Track™ you may wish to invest in a stand up drill so that you do not have to bend over to set every screw when glueing and screwing Comfort Track™ to a subfloor. In absence of a groove alignment tool, cut short (6") pieces of PEX pipe. These can be used to align the grooves of the boards during installation by snapping them into the grooves with 3" in the groove on each board. Once the board is secured they may be removed prior to the installation of the pipe

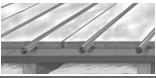

LAYOUT AND INSTALLATION:

INSTALLATION STEP 1: Utilization a plan layout, determine panels needed (See material takeoff) and tubing lengths required. Be sure to always use good judgement in allowing enough tubing at ends for leaders up to manifolds. A plan should indicate which type of system will be implemented (See construction methods).

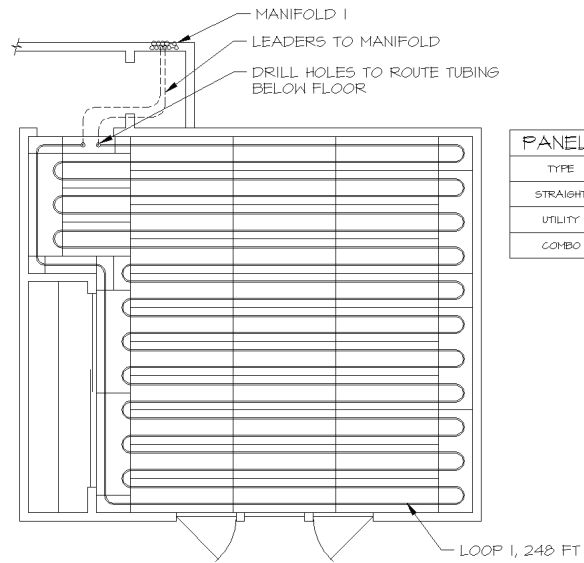

| PANEL SCHEDULE | |
|----------------|----------|
| TYPE | QUANTITY |
| STRAIGHT | 36 |
| UTILITY | 3 |
| COMBO | 4 |

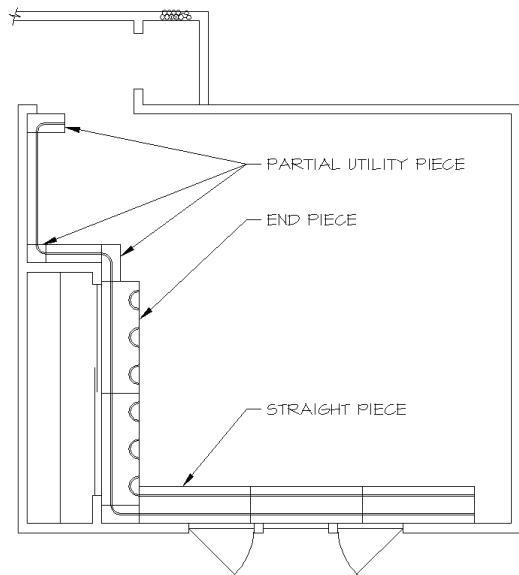

INSTALLATION STEP 2: Begin the Comfort track™ layout by starting at the beginning of the supply run into the space and running board along the perimeter of the heated space to the area of highest heat loss.

DETAIL SHOWING SPACING BETWEEN BOARDS:

This gap is “built-in” to standard board dimensions. (15 7/8” board width)

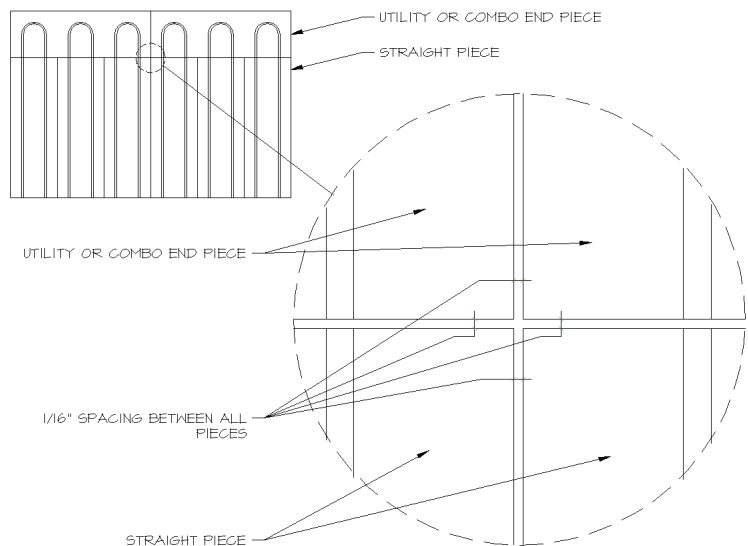

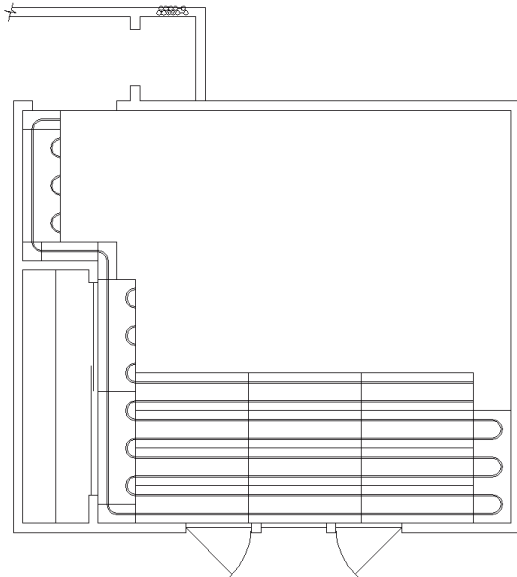
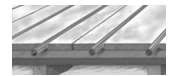

INSTALLATION STEP 3:

Add end pieces and straight pieces working your way back away from the area of heat loss. Once all boards are in place, drill holes (subfloor with access application) or route leader back to manifold via custom grooves or grout (slab or existing subfloor application) for supply and return leaders to manifolds.

INSTALLATION STEP 4:

Feed supply tubing (enough to route to manifold) through drilled supply hole below the floor. Tubing may then be “popped” into grooves. After all grooves have been thoroughly cleaned. Once tubing has been routed back to return hole, cut enough to route to return manifold.

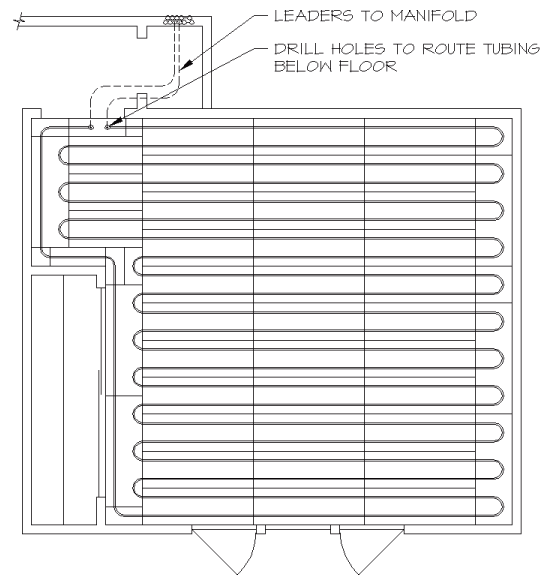

ADDITIONAL APPLICATION GUIDELINES:

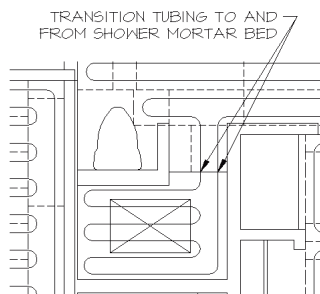

SPECIAL COVERAGE AREAS:

In areas of special coverage such as shower basins using tile grout as a base, tubing may be routed to and from Comfort track™ in order to accommodate desired coverage.

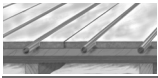

GLUING, AND SCREWING PATTERNS:

For full size pieces (16" x 48") ten screws should be used, 8 on the perimeter as shown and 2 in the middle or general 16" O.C. for the perimeter and 24" O.C. for the interior. Use Construction adhesive type glue at minimum 1/8" bead in the gluing pattern shown on the bottom of all boards

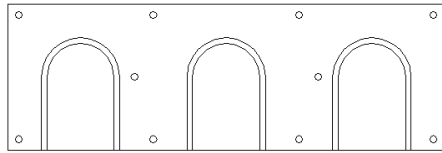

UTILITY ATTACHMENT PATTERN

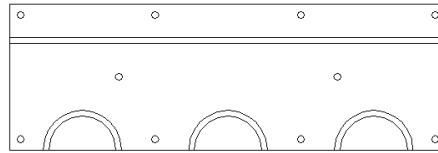

COMBO ATTACHMENT PATTERN

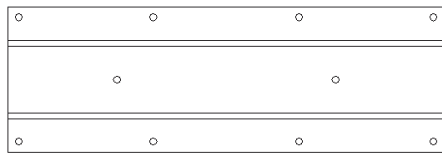

STRAIGHT ATTACHMENT PATTERN

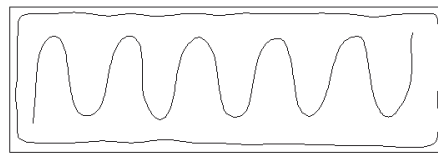

GLUEING PATTERN

ALTERNATIVE TO GLUING AND SCREWING: GLUING AND CROSS STAPLING

As an alternative to gluing and screwing Comfort track™ may be installed by gluing and stapling as shown below. When installed with this method it is very important that the board is glued and stapled with at least as much glue and staple points as shown in the screwing pattern, and that the boards be cross stapled as shown for extra strength.

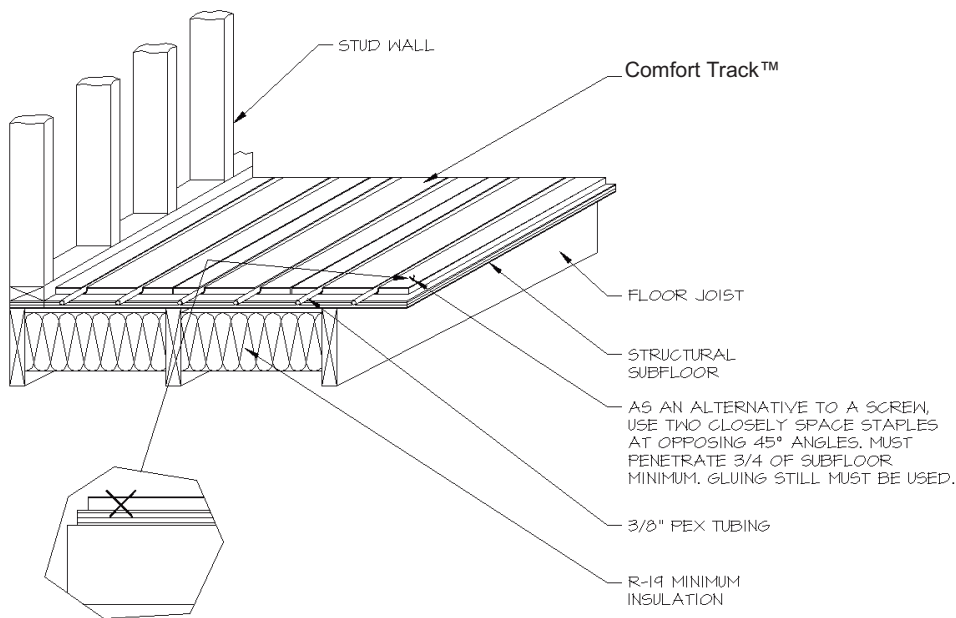

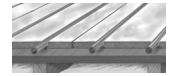

NOTE ON THERMAL CAULK IN GROOVES:

There is, intentionally, a tight tolerance between the PEX tube and the groove. Use Silicon Caulk ONLY IF THERE IS SUFFICIENT SPACE WITHIN THE GROOVE to accommodate the tube and a small quantity of of silicon caulking.

CONNECTIONS AT MANIFOLD:

In situations where there are several loops from a single area running into one manifold and it is not possible to route tubing below subfloor two methods may be used to run tubing to the manifold:

- 1) A solid MDF sheet may be placed next to the manifold in which supply and return lines are custom routed to the wall at the manifold.
- 2) Tubing may be run out of the Comfort track™, stapled to the subfloor and routed directly to the manifold. A grout may then be used to cover the tubing and leveled to the Comfort track™. If needed sleepers are placed in between tubing to provide a nailing or screwing base for floor coverings. Use nailing plates as necessary to protect tubing from damage.

Depending on how many circuits are on a given manifold varying sizes of sheets or grouting area are required.

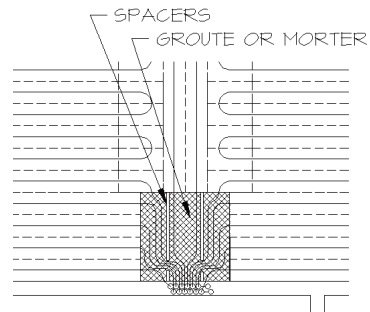
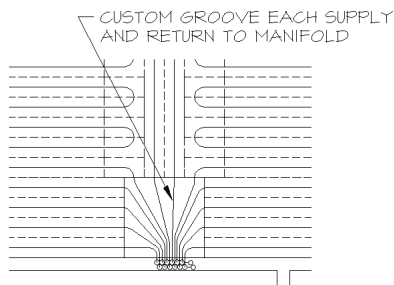

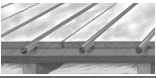

APPLICATION – CARPET OVER SUBFLOOR

Carpet and pad may be installed over Comfort Track™. When installing pad, care should be taken avoid puncturing tubing. It is advised that a thin layer of underlayment plywood be applied over Comfort track™ prior to carpet and pad installation to protect tubing from point loads. As with all radiant heating installations, a thin slab foam rubber pad and short, high density carpet should be used. If carpet pad is glued, a high temperature latex adhesive must be applied, glue to underlayment plywood, do not glue to Comfort Track™ or to tubing!

Installation:

- 1) Thoroughly clean all surfaces that Comfort Track™ will be applied to. The surface to which Comfort track™ will be attached must be flat and dry prior to installation.
- 2) Chalk lines of a square reference point, as construction of walls may out of square
- 3) Lay out boards according to plan.
- 4) Be sure to use adequate adhesive.
- 5) Start layout of all pieces by securing a corner to allow for proper alignment.
- 6) Use groove alignment tool to ensure proper alignment of boards.
- 7) A 1/16" width space shall be used between boards.
- 8) Once all boards are installed clean out all grooves with a vacuum.
- 9) Snap tubing into groove and route to manifold per plan.
- 10) Maintain 2" minimum tubing clearance from carpet tack strips.

Refer to the complete installation manual for further instructions on the installation of the Comfort Track™ system.

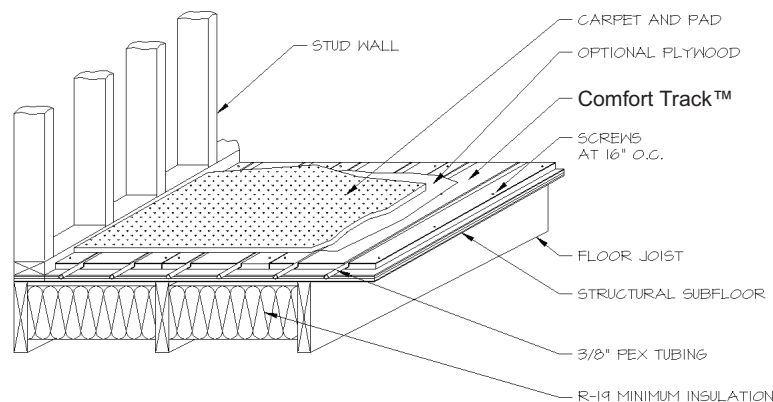
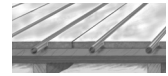

ILLUSTRATION A-5, CARPET OVER SUBFLOOR



APPLICATION – LAMINATE OR VINYL OVER SUBFLOOR

When installing vinyl flooring it is required, and when installing laminate flooring It is advised that a thin layer of underlayment plywood be applied over Comfort track™. In wet locations a sealant layer should be added as shown in details for wet locations tile/stone. Underlayment plywood that has a grid printed on it helps locate tubing runs and avoid puncturing tubing when the plywood is being screwed to the Comfort Track™. In the case of vinyl use underlayment, filler and glues suggested by the manufacturer for use over radiant heat. Most vinyl flooring is manufactured to an ASTM standard with an upper limit of floor temperatures of 85°F. This should be followed. Many, but not all, laminate flooring products are suitable and recommended by the manufacturer for use with radiant floor heat. Check before installing. Many laminate flooring products have floor temperature limits that need to be observed as well.

Installation:

- 1) Thoroughly clean all surfaces that Comfort track™ will be applied to. The surface to which Comfort track™ will be attached must be flat and dry prior to installation.
- 2) Chalk lines of a square reference point, as construction of walls may out of square
- 3) Lay out boards according to plan.
- 4) Be sure to use adequate adhesive.
- 5) Start layout of all pieces by securing a corner to allow for proper alignment.
- 6) Use groove alignment tool to ensure proper alignment of boards.
- 7) A 1/16" width space shall be used between boards.
- 8) Once all boards are installed clean out all grooves with a vacuum.
- 9) Snap tubing into groove and route to manifold per plan.
- 10) Attach underlayment, if required, with care to not puncture tubing.
- 11) Install laminate flooring crosswise to Comfort Track™ whenever possible

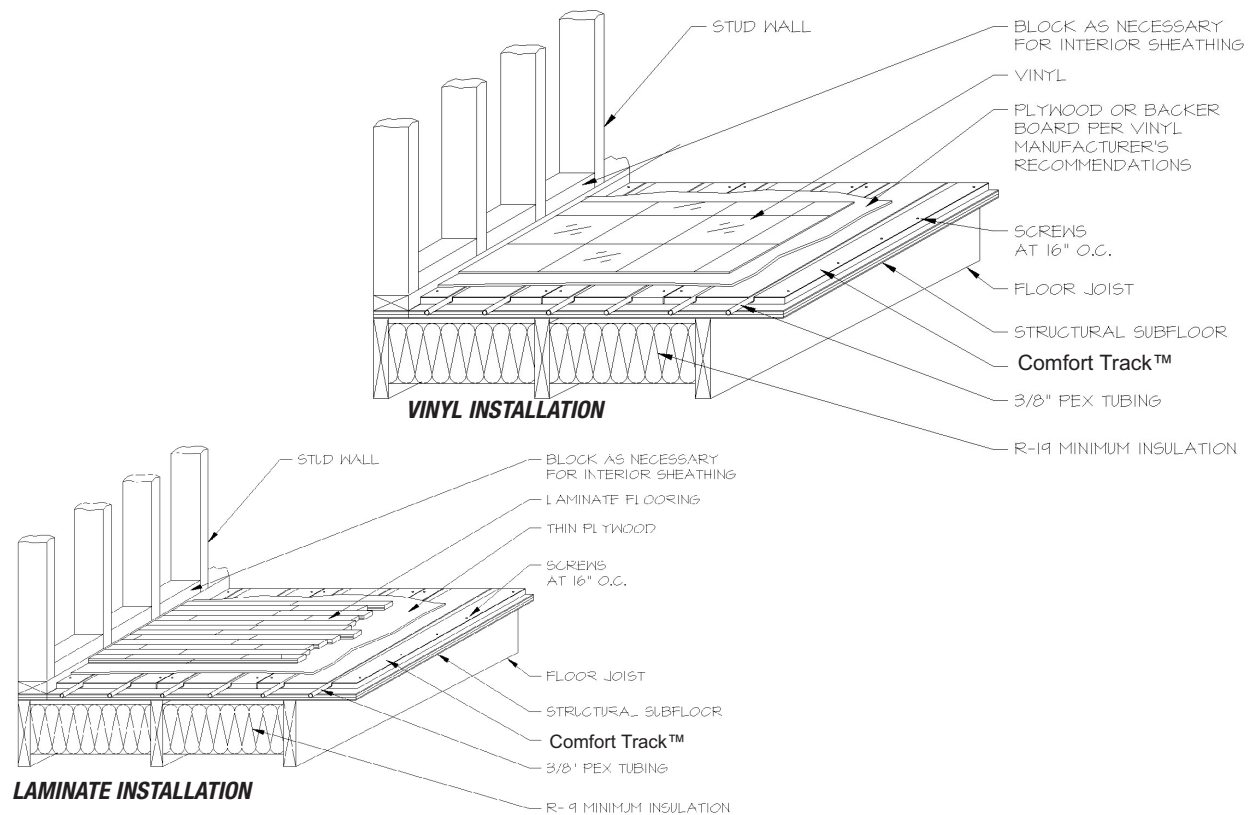

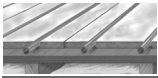

APPLICATION OPTIONS – WOOD FLOORS OVER COMFORT TRACK™:

Comfort Track™ may be used under wood flooring in several ways:

1) Conventional nailed and hardwood type system may be used directly over Comfort Track™ with nailing long enough to penetrate sub-floor as described in the following section. When wood flooring systems are installed directly over Comfort Track™ the hydronic heating system, should employ controls that gradually adjust water temperature going to the Comfort Track™ with a reset curve. See details of this method on following pages.

2) Optionally 2 layers of 1/2 inch plywood may be floated on top of the Comfort Track™ and strip flooring nailed to it, as shown below in a method recommended by the National Wood Flooring Association. This method has the advantage that it allows the wood flooring system to float independently from the Comfort Track™ but has significant disadvantages in that the 1” extra thickness of wood limits the output of the system. For example 2 layers of 1/2” plywood with 3/4” of strip oak flooring has an R-value of about R-2.3. This limits the output of the floor at 150° F water temperature to about 26 BTU/Square Foot. A careful heat loss analysis must be done to see if this method will produce enough heat. If not another method should be chosen or provisions made for backup heat. A hydronic control strategy that gradually adjust water temperature going to the Comfort Track™ with a reset curve is recommended but not required with this method.

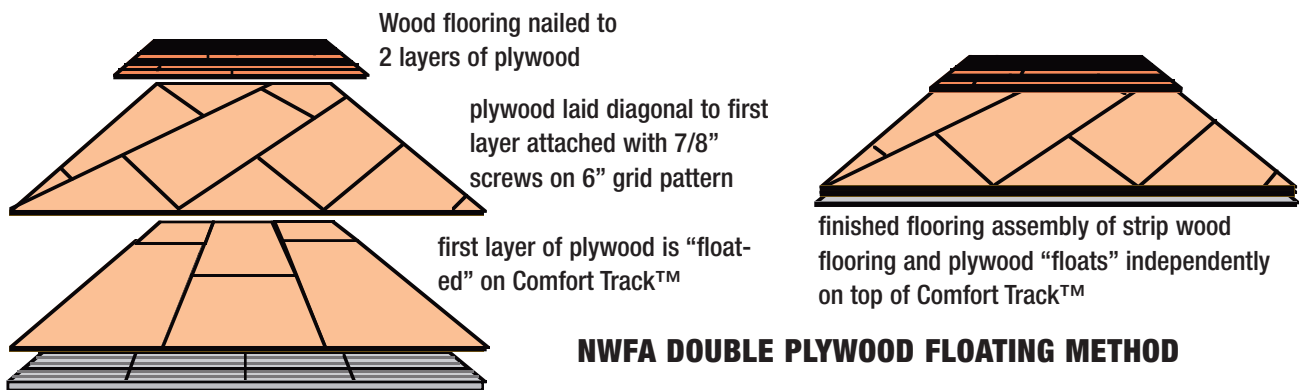

3) Clip style floating strip flooring systems must be installed directly over Comfort Track™ such that clips will never come in contact with tubing.

4) The preferred wood flooring over any radiant heating system is to use a floating wood floor with a specific warranty for use over radiant floors. Many manufacturers of these products have such a warranty as well as having extensive experience both in Europe and North America with radiant heating applications. Edge glued floating engineered wood flooring systems are preferred since they are dimensionally stable, and expand independently from any thermal mass. Comfort track™ should be installed such that the hardwood runs perpendicular to the majority of the tubing runs.

5) Glued down wood flooring systems are not recommended unless a layer of plywood is first screwed down to the Comfort Track™ and the wood is attached to the plywood according to the flooring manufacturers recommendations for installation over radiant heat.

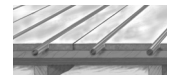

APPLICATION – HARDWOODS OVER SUBFLOOR:

Conventional nailed and hardwood type system may be used directly over Comfort Track™ with nailing long enough to penetrate subfloor.

Installation:

- 1) Thoroughly clean all surfaces that Comfort Track™ will be applied to.
- 2) Chalk lines of a square reference point as construction of walls may be inconsistent
- 3) Lay out boards according to plan.
- 4) Be sure to use adequate adhesive.
- 5) Start layout of all pieces by securing a corner to allow for proper alignment.
- 6) Use groove alignment tool to ensure proper alignment of boards.
- 7) A 1/16" width space shall be used between boards.
- 8) Once all boards are installed clean out all grooves with a vacuum.
- 9) Snap tubing into groove and route to manifold per plan.
- 10) Care should be taken to avoid nailing tubing.
- 11) Do not end hardwood floor joint at Comfort Track™ joint.
- 12) Hardwood floor nails should be long enough to penetrate both hardwood and subfloor.
- 13) employ controls that gradually adjust water temperature going to the Comfort Track™ with a reset curve.
- 14) It is extremely important that the designer know which way it is desired that the strip flooring be aligned prior to the design of the Comfort Track™ system since the direction of the Comfort Track™ should run perpendicular to the direction of the strip flooring.
- 15) Install strip flooring with mallet driven nails and nails penetrating the Comfort Track™ 1/2" into the subfloor
- 16) Use 15 gauge nails (2.5" with 3/4" floors) to penetrate subfloor.
- 17) A nailer such as the Senco # SFM40 with a tongue and groove attachment # SFM40 TG should be used
- 4) Keep structure humidity within the range specified by the manufacturer.
- 18) Install the wood at the relative humidity recommended by the manufacturer for the climate involved.
- 19) Use narrower 2"-3 1/2" strips over radiant floors.
- 20) The lessons of local practice and climate should be referenced
- 21) Make sure the heating system has been running and the space has been maintained at least 65F° long enough that temperature and humidity have stabilized to predicted future levels.
- 22) Let the product acclimatize before installation.

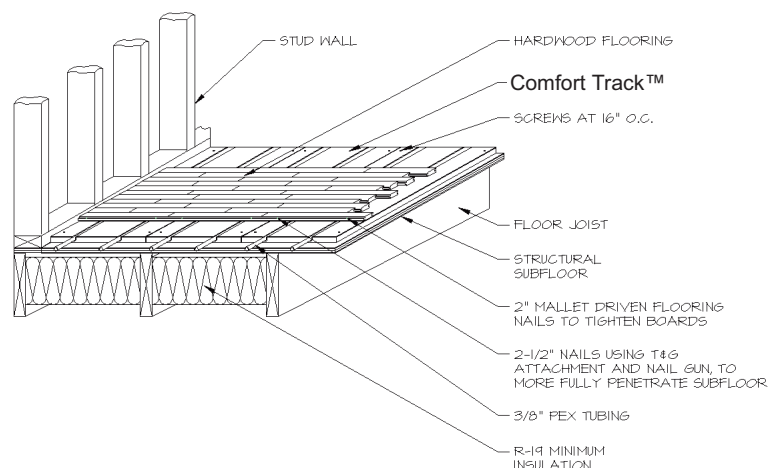

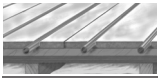

CONSIDERATIONS WITH TRADITIONAL WOOD FLOORING OVER COMFORT TRACK™

The key to installing wood floors over radiant heat is to give extra care to wood species, wood width and thickness, moisture levels, installation practices, the heat output requirements of your system, and radiant heating control.

BOARD WIDTH: Install narrow board widths, preferably 3 inches or less. Avoid boards wider than 4 inches. Narrow boards provide more gaps for expansion and contraction across a floor; therefore, gaps resulting from natural movement are much less noticeable. The maximum recommended board depth is 3/4 inch. Thicker boards add too much resistance to heat transfer.

DIMENSIONAL STABILITY: Use quarter sawn wood. It's significantly more dimensionally stable than wood that is plain sawn. Pick a wood that's known for its dimensional stability. American cherry, ash, most softwoods and teak fill this bill, and oak is reasonably stable. By contrast, hickory, maple, madronne and American beech are known as less stable.

AGE & DRYING IN TROPICAL WOODS: If you're importing tropical or exotic woods, pay close attention to the source, age and how the wood has been dried. Tropical wood needs to dry slowly. Quick drying creates stresses that can affect the wood later as it expands and contracts. If your supplier has stored the wood in your region with no problems for one to two years, surprise stress-related problems are much less likely. Though it can be fun to be unique, avoid pioneering the use of a wood where there is little information on its dimensional stability.

MOISTURE: Wood naturally expands and contracts in response to changes in moisture. With this in mind, avoid installing wood flooring during stages like sheet rocking or painting, when significant moisture may be introduced into a structure. Operate the heating system until the humidity in the structure stabilizes to the average level expected for the area in which the wood floor will be installed. Then, allow the wood to acclimatize to this humidity level by "sticking" (usually several weeks) before installation. This will minimize dimensional changes due to moisture. Make sure the wood is dry, since radiant heat itself can be drying. Experienced flooring installers recommend buying wood for radiant at around 6 to 8 percent moisture content. This figure may change some regionally. Use a moisture meter during the construction process, and then use the average of many readings. Remember, the average expected humidity level of a structure is an average of seasonal conditions. So if the structure is expected to average 30 percent humidity in the winter and 50 percent in the summer, the average would be 40 percent. This equates to about a 7.5 percent moisture content in the wood. Most installers consider this average the ideal moisture level at which to install wood flooring. These numbers can vary significantly by region.

SURFACE TEMPERATURE: The maximum surface temperature of a wood floor should be limited to 85°F. Use a control strategy that assures this will not be exceeded and brings the floors through temperature changes gradually.

HUMIDITY CONTROL

In climates with large humidity variations, install humidity control. In vacation cottages with intermittent use, consider back sealing boards before installation to make them more stable to changes in moisture in the structure.

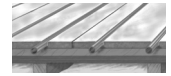

APPLICATION – TILE OR STONE OVER SUBFLOOR:

For masonry Tile and Stone it is recommended that backer board be used over Comfort Track™. Conventional mortar bed or thin set installation may then be used. In Kitchen, Baths, Laundry or any other area where water may be present, water sealant (Nobleseal) shall be used. Where tile is going to be thin-set, anti-fracture membrane (Nobleseal) shall be used.

Installation:

- 1) Thoroughly clean and level all surfaces that Comfort Track™ will be applied to.
- 2) Chalk lines of a square reference point as construction of walls may be inconsistent
- 3) Lay out boards according to plan.
- 4) Be sure to use adequate adhesive.
- 5) Start layout of all pieces by securing a corner to allow for proper alignment.
- 6) Use groove alignment tool to ensure proper alignment of boards.
- 7) A 1/16" width space shall be used between boards.
- 8) Once all boards are installed clean out all grooves with a vacuum.
- 9) Snap tubing into groove and route to manifold per plan.
- 10) Maintain 2" minimum tubing clearance when screwing backer board down.

Refer to the complete installation manual for further instructions on the installation of the Comfort Track™ system.

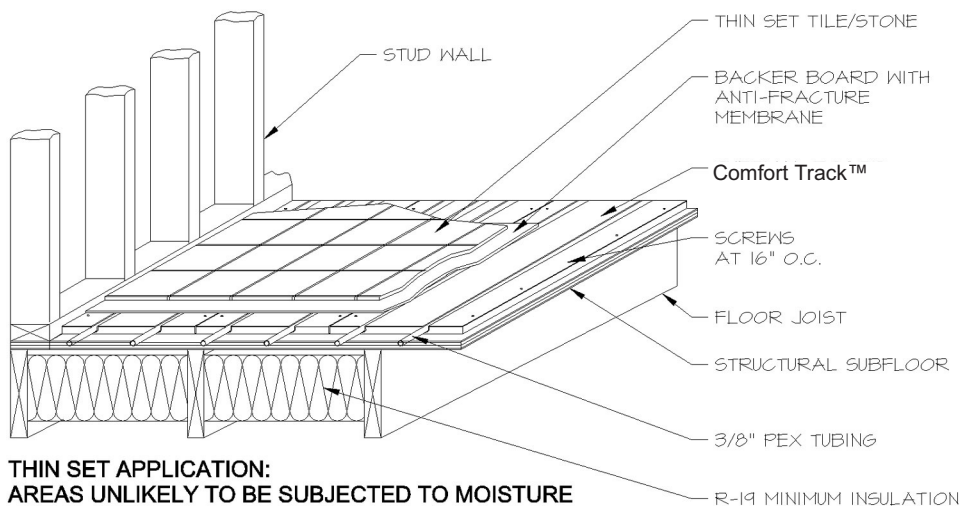

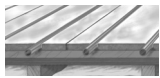

TILE AND STONE: MORE DETAILS

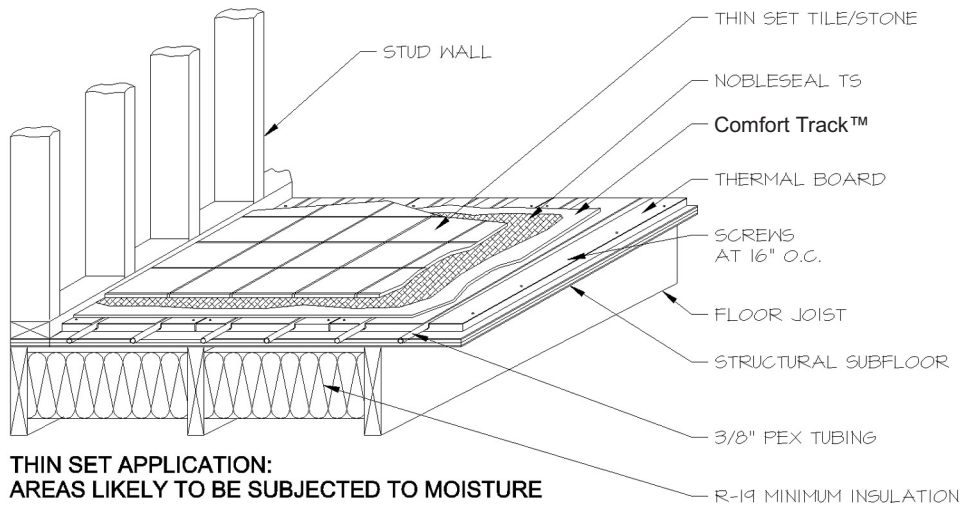

NOTE ON SEALING Comfort Track™ :

The aluminum layer on the top of each Comfort Track™ is highly water resistant, this means that a significant degree of moisture protection can be given to the board simply by using the silicon sealant as a caulk between the boards. Properly applied, this will profoundly reduce the likelihood of water transmission into the boards.

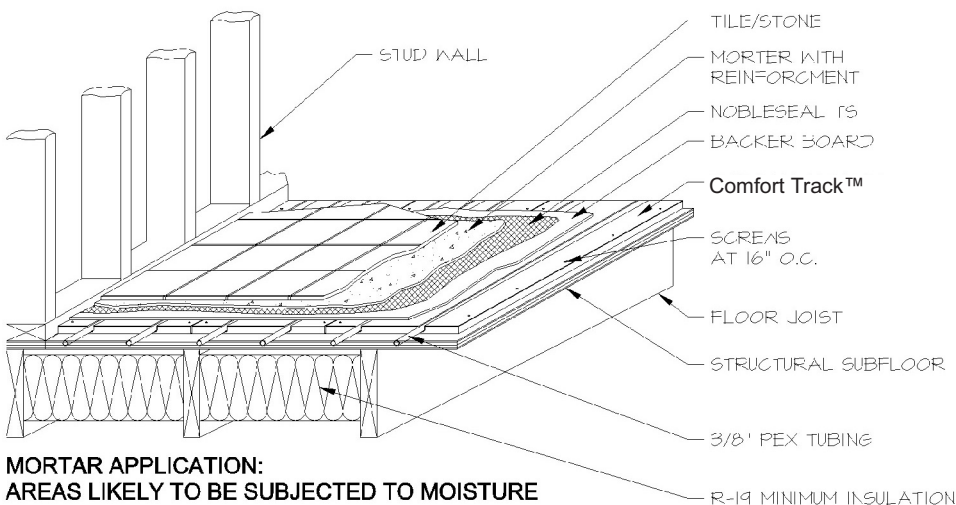
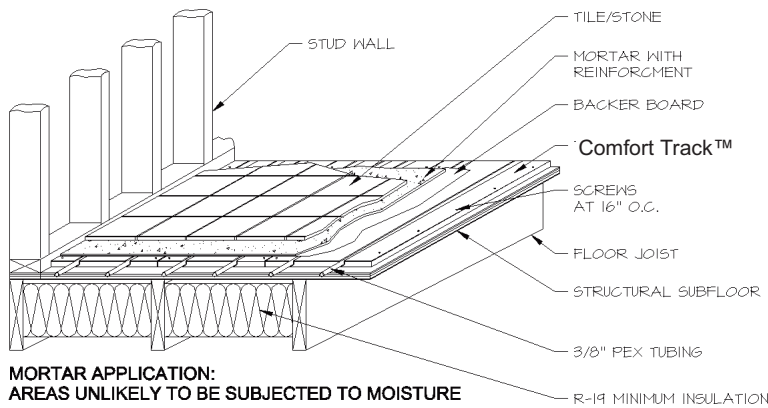

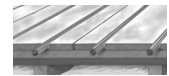

APPLICATION – OVER SLAB:

CONCRETE REQUIREMENTS:

Since all concrete slabs give off supplementary moisture whether above, on, or below grade, it is strongly recommended that all slabs below grade and slabs on grade be sealed against moisture penetration before installing Comfort Track™. A product such as Hydroment Ultraseal may be used. Comfort Track™ is then glued down using wood flooring adhesive rated for use with radiant floor temperatures. An alternate method using Homosote is also shown. This has the benefit of adding some insulation between the slab and the Comfort Track™. Remember that while a slab may appear to be or be dry during one time of year, this may change as environmental conditions change. Below is a procedure for testing moisture of above grade slabs such as between floors in commercial construction. When in doubt seal the slab before proceeding with the installation.

Initially, check the moisture by taping a 2 ft. x 2-ft. piece of polyethylene film in at least 2 or 3 locations (more in large areas). A rubber-backed mat can be used instead of the polyethylene film. Indications of a high moisture content include darker or discolored concrete, cloudy polyethylene film or condensation on the underside of the film. A moisture meter may be used, but it can only be used as an indicator because different additives in concrete can cause misleading results. If there are any indications of a high moisture content, use a test method that will determine the exact moisture content of the slab based on its dry weight, or use a calcium chloride test. When using the 6 mil polyethylene vapor barrier, the moisture content must not exceed 2.5% on a dry weight basis. With a calcium chloride test, the maximum acceptable reading is 5 lbs./ 4 hours/ 1,000 sq. ft. New concrete slabs and basements must be cured for a minimum of 60 days prior to installation. Remember, it is recommended that all slabs be sealed against moisture penetration before installing Comfort Track™.

After determining that the new existing or new slab is sufficiently dry, and sealing the slab you may proceed with the Comfort Track™ installation.

For masonry tile and stone flooring it is recommended that backer board be used over Comfort Track™. Conventional mortar bed or thin set installation may then be used, as shown in the details. For vinyl and carpeting it is recommended that 1/4" underlayment plywood be installed on the Comfort Track™ before the finish flooring. Carpet pad should avoid being stapled due to tubing being obscured. . As with all radiant heating installations, a thin conductive rubber pad and short, high density carpet should be used. Use of vinyl floors and associated adhesives and materials should be checked for temperature limitations. Conventional and floating type wood floor systems may be used directly over Comfort Track™. Floating laminated wood floors are preferred. Traditional strip wood floors require that 3/4" T&G plywood is first glued to the slab. Tubing is visible so hardwood may be directly nailed to Comfort Track™ or floating methods may be used as shown elsewhere in this manual. See additional notes on installing wood floors elsewhere in this manual. Comfort Track™ should be installed such that the hardwood runs perpendicular to the majority of the tubing runs.

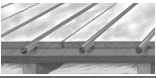

APPLICATION OVER SLAB, REGULAR FLOOR GOODS EXCEPT STRIP WOOD FLOORING:

INSTALLATION OVER CONCRETE:

- 1) Thoroughly clean and level all surfaces that Comfort Track™ will be applied to.
- 2) Seal concrete with vapor membrane such as Hydroment Ultraseal per manufacturers guidelines.
- 3) Chalk lines of a square reference point as construction of walls may be inconsistent
- 4) Lay out boards according to plan.
- 5) Be sure to use adequate adhesive compatible with vapor membrane to glue down the Comfort Track™ to the membrane.
- 6) Start layout of all pieces by securing a corner to allow for proper alignment.
- 7) Use groove alignment tool to ensure proper alignment of boards.
- 8) Once all boards are installed clean out all grooves with a vacuum.
- 9) Snap tubing into groove and route to manifold per plan.
- 10) Install backerboard when applying tile or vinyl floor goods
- 11) Maintain 2" minimum tubing clearance from carpet tack strips or other nailing.

Refer to the complete installation manual for further instructions on the installation of the Comfort Track™ system.

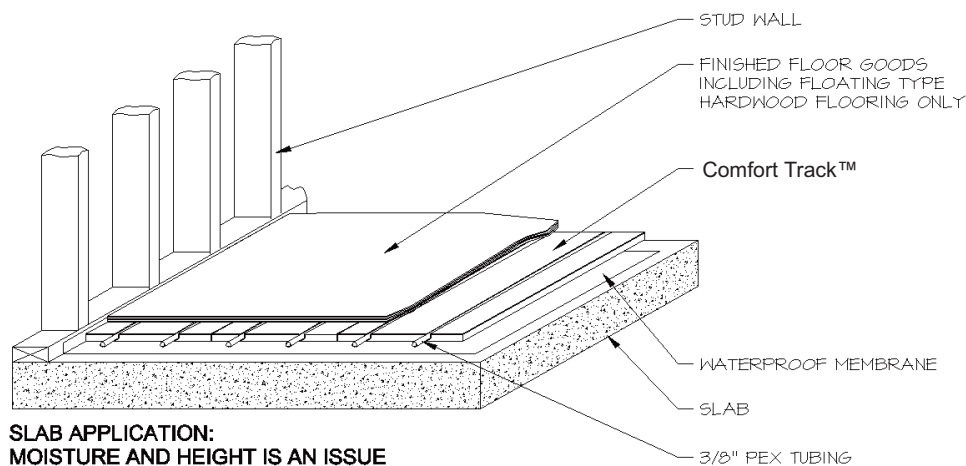

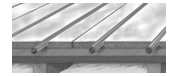

APPLICATION OVER SLAB, STRIP WOOD FLOORING

INSTALLATION OVER CONCRETE:

- 1) Thoroughly clean and level all surfaces that Comfort Track™ will be applied to.
- 2) Seal concrete with vapor membrane such as Hydroment Ultraseal per manufacturers guidelines.
- 3) Glue T&G 3/4" plywood down to vapor membrane. Be sure to use adequate adhesive compatible with vapor membrane to glue down the plywood to the membrane. Weight the plywood if necessary to make it lie flat
- 4) Chalk lines of a square reference point as construction of walls may be inconsistent
- 5) Lay out boards according to plan.
- 6) Glue and screw or staple Comfort Track™ to plywood. Be sure to use adequate adhesive.
- 7) Start layout of all pieces by securing a corner to allow for proper alignment.
- 8) Use groove alignment tool to ensure proper alignment of boards.
- 9) Once all boards are installed clean out all grooves with a vacuum.
- 10) Snap tubing into groove and route to manifold per plan.
- 11) Install strip flooring with mallet driven nails and 15 gauge nails of sufficient length to give 1/2" penetration into plywood.
- 12) Insulfoam/plywood combination may be used instead of plywood alone in strip flooring provided the plywood layer is at least 5/8" thick, (3/4" preferred) and the foam can be bonded with a compatible adhesive to the vapor membrane.

Refer to the complete installation manual for further instructions on the installation of the Comfort Track™ system.

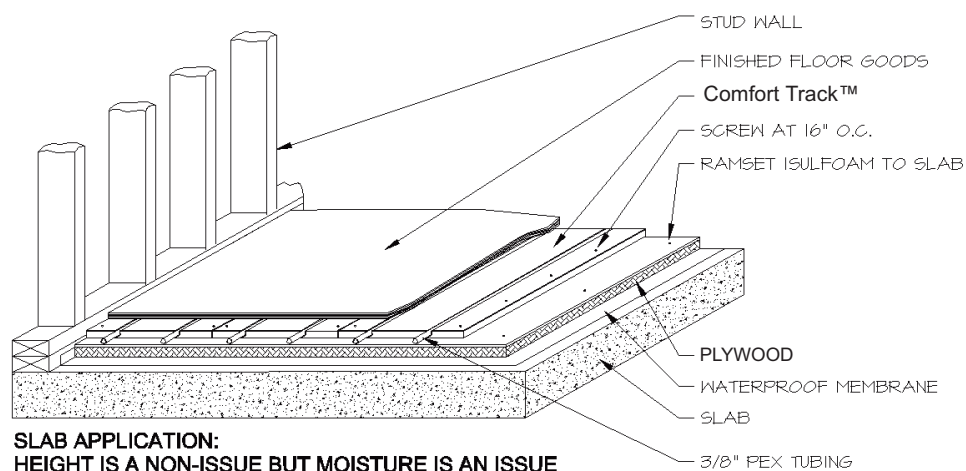

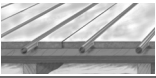

APPLICATION – WALL

Installation:

- 1) Install Comfort Track™ level to the floor.
- 2) Screw Comfort Track™ to studs on both sides of groove.
- 3) Start layout of all pieces by securing a corner to allow for proper alignment.
- 4) Use groove alignment tool to ensure proper alignment of boards.
- 5) Once all boards are installed clean out all grooves with a vacuum.
- 6) Snap tubing into groove and route to manifold per plan.
- 7) Maintain 2" minimum tubing clearance from all nailing. Add steel plate protectors where tubing crosses studs.
- 8) Do not exceed 120F° supply water temperatures.
- 9) Ceiling detail similar but to follow in future manuals

Refer to the complete installation manual for further instructions on the installation of the Comfort Track™ system.

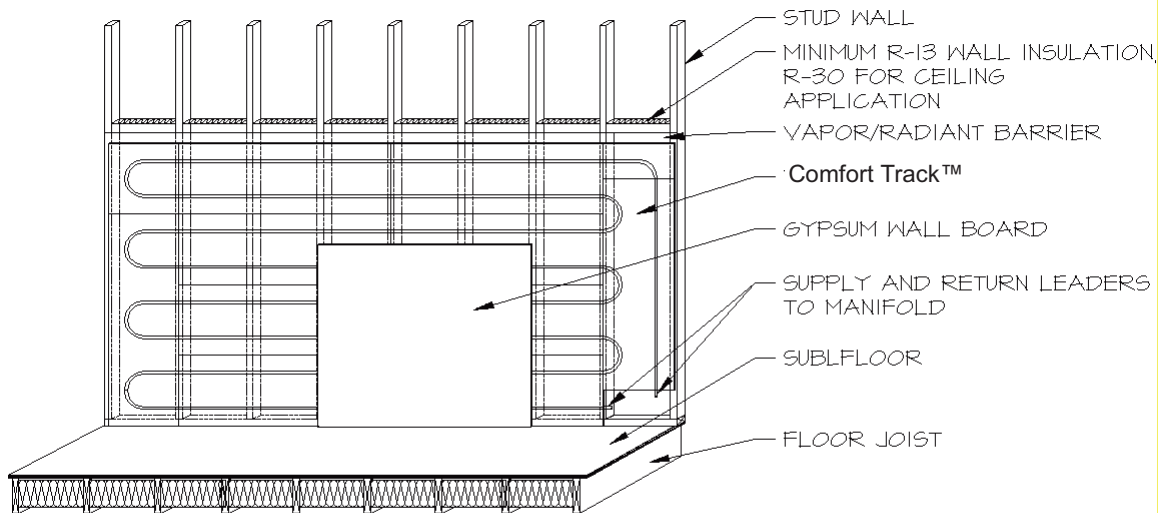

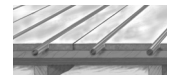

DESIGN SERVICES:

Professional Comfort Track™ CAD Layouts are provided by
National Radiant Design Center

227 Forest Avenue, Suite 5 , Pacific Grove, CA 93950

www.designradiant.com mail@designradiant.com

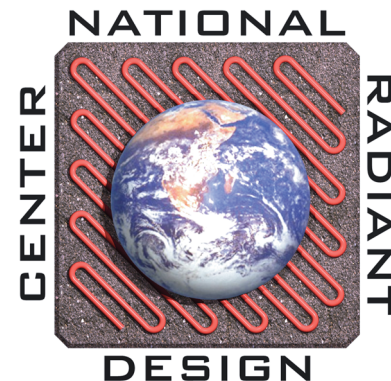

Radiant Heating Design

Many poor performing heating systems are often the result of improper design due to inaccurate heat loss on a room-by-room basis, which may result in an undersized or inefficient oversized system. With the flexibility that radiant heating provides, it is imperative that a system be designed such that there is no excessive or inadequate heating in different areas. The type of system must be selected based on the level of sophistication and many factors that affect system output such as insulation values, floor coverings, multilevel interaction, floor temperature limitations, heat source type as well as many other factors that go into the design process. All these conditions are used with the aid of computer simulation to maximize efficiency and cost effectiveness of a system

The NRDC Design Advantage

As a national leader and independent source of design and consultation, NRDC works with homeowners, architects, installation contractors, and manufacturers to design custom or production heating systems for a variety of both residential and commercial buildings. With over 15 years of experience in the radiant industry and having designed over 1,300 systems over much of the US and many parts of the world, NRDC has the experience and knowledge to design a perfect operating system that best matches the type of construction.

An NRDC design – What you get

- 1) Full size sheets showing plan view of tubing layout including locations of manifolds, heat source and components
- 2) System balancing data – computer simulation report that allows the installer to properly balance the system for optimal performance.
- 3) Complete component schematic including specifications on heat sources, pumps, valves, manifolds, expansion tank, etc. and sizing of distribution piping.
- 4) Installation notes and details
- 5) Additional (Optional) heat source specification
- 6) System controls page providing options on controls schemes



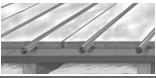

**NRDC designs conform to both RPA and I=B=R standard guidelines for the design and installation of radiant heating system.*

BENEFITS OF DESIGN:

Owner:

As an owner, having NRDC design a system that matches the construction type, you will have piece of mind of having a system work properly and with the desired functionality in your new or retrofit application. NRDC works with the client to provide all the options including advantages/disadvantages on various types of systems and will work to match a system that best matches the construction type. With NRDC's expertise, options on different heat sources and controls are presented to allow the customer to make good decisions on their comfort system. When it comes time for installation of a system, using an NRDC plan, the owner can get "apples to apples" bids from prospective installation contractors. As a radiant heating system typically adds value to the home, an NRDC plan provides a permanent record of the system for resale or for future renovations. Owners can rest easy knowing that with an NRDC designed system they will have the most comfortable heating system that can be provided.

Architect or Designer:

As is often required by building departments, an NRDC plan may be used as a complete mechanical system than can be incorporated into submittal plans. A "complete heating system design" may be used as a selling feature to a

client. Having worked on thousands of different types of construction, NRDC can offer expert advice for the integration of the mechanical system into the design as well as advice on which type of system is best suited for different types of construction. NRDC may provide information on integration of the system into the building controls if applicable. Consultation is available on how systems will work with different floor coverings, ceiling heights, window configurations and multi-level, multi-zoned homes and buildings.

Installation contractor:

With a complete NRDC plan, the installation contractor can quickly get material takeoffs for bids. All components including distribution piping are already sized including exact circuit lengths. NRDC provides balancing data for all circuits in a clear concise table. Spend less time fumbling with design aspects and more time getting systems installed. NRDC plans are a good selling feature when speaking to prospective clients as having "plans engineered to ensure proper operation". With a plan the client will know exactly what they are getting prior to work, which saves time for you and the client in the long run. You will also be providing the owner with a clear, permanent record of the system.

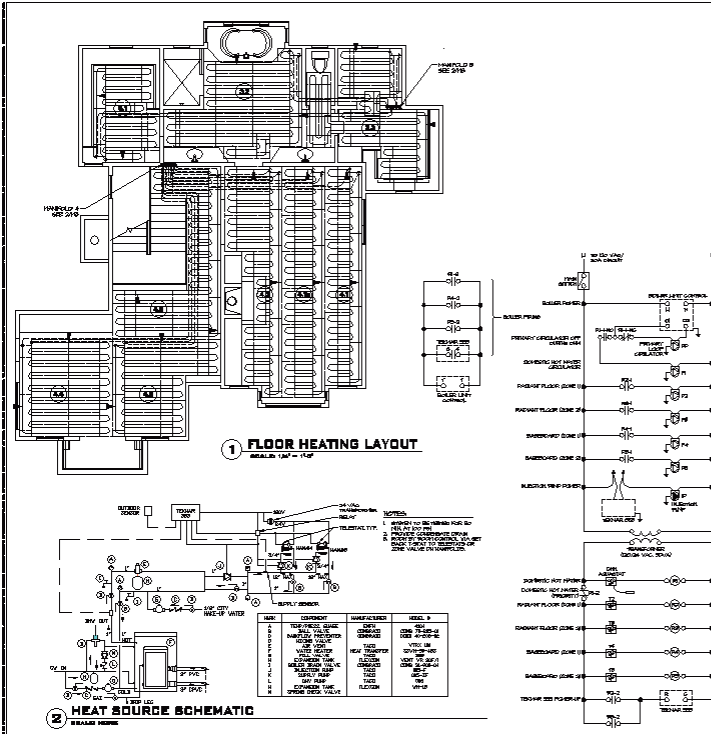
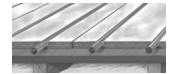

Scaled plan showing exact board and circuit layout with lengths and manifold locations

System Installation Notes

Computer simulation output showing flow rates, temperature and balancing data

Controls ladder diagram

Mechanical room installation schematic showing arrangement of components including controls and connections heat source.

PROVISIONS: RVT

NATIONAL RADIANT DESIGN CENTER

JOHNSON RESIDENCE

FLOOR HEATING PLAN

M 1

Application methods for varying types of construction and floors and additional system details.

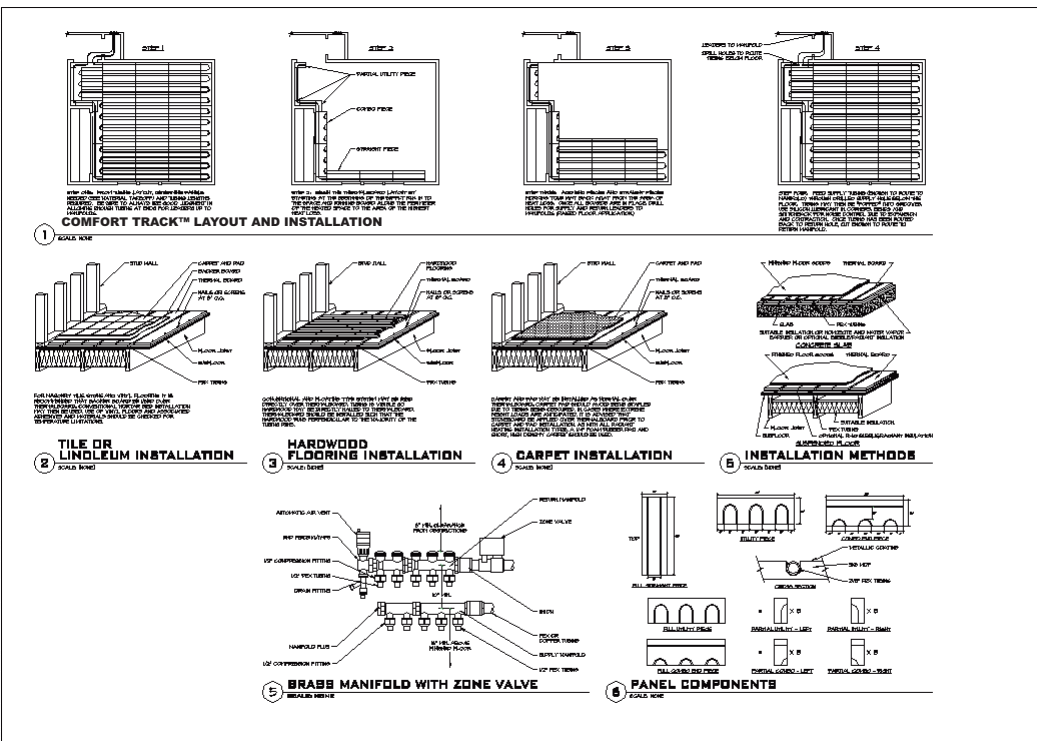

PROVISIONS: RVT

NATIONAL RADIANT DESIGN CENTER

JOHNSON RESIDENCE

FLOOR HEATING PLAN

M 2

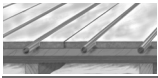

CAUTIONS AND LIMITATIONS OF USE:

Installer Caution:

This manual is deemed to be current at the time of publication. It is the installers responsibility to install according to the most current application Guide. This guide does not purport to address all relevant issues; it assumes a knowledge of good practice in both hydronics and construction methods. Installers should always consult all relevant local, regional and national codes, and adhere to good construction practice. Comfort Track™ should only be installed by knowledgeable qualified installers. Comfort Track™ installations frequently require the coordination of trades. These are, most typically, mechanical and flooring trades. Any issues regarding this coordination should be worked out in advance. Failure to follow the instructions of this guide, failure to adhere to relevant local, regional and national codes, failure to coordinate trades and failure to follow good construction practise may cause an unsatisfactory result. See also “limitations of use” elsewhere in this publication. The limitations and instructions of use for PEX pipe and other hydronic components provided by the manufacturers shall also be referenced and followed during installation; this manual does not address many aspects of a hydronic installation.

Limitations of use:

Comfort Track™ is designed for interior use only and is to be installed only on dry substrata once a structure is closed in, protected from the environment and will remain dry. Comfort Track™ is not intended as or rated as a replacement or substitution for a structural subfloor. The BTU output of Comfort Track™ is limited by the R-values of the finish goods applied over it and recommended and available water temperatures. Comfort Track™ is not intended for use where the BTU output and water temperatures exceed those recommended in this manual. Comfort Track™ is not intended for use with finish goods that are incompatible with the temperatures and conditions present in a radiant heating system. Comfort Track™ is not intended as a finish floor and should be left uncovered and unprotected only during installation.

Comfort Track™ IS A PATENTED PRODUCT AND IS SOLD UNDER LICENSE FROM WARM BROTHERS INC.



315 Oser Avenue, Hauppauge, NY 11788
Phone: (631) 694-1800 • Fax: (631) 694-1832